

IC234 Series (Open Top)

Quad Flat Package (QFP) - Shoulder Contact Type

Specifications

Insulation Resistance: 1,000M Ω min. at 100V DC, pitch 0.4, 0.5
 1,000M Ω min. at 500V DC, pitch 0.65, 0.8

Dielec. Withstd. Voltage: for 1 minute at 100V AC, pitch 0.4, 0.5
 for 1 minute at 500V AC, pitch 0.65
 for 1 minute at 700V AC, pitch 0.8

Contact Resistance: 30m Ω max. at 10mA/20mV max.

Operating Temp. Range -40°C to +150°C

Contact Force 20g to 80g per pin

Mating Cycles: 10,000 insertions min.
 5,000 insertions min. (IC234-1004-009)

Materials and Finish

Housing: Polyetherimide (PEI), glass-filled
 Polyethersulphone (PES), glass-filled

Contacts: Beryllium Copper (BeCu)

Plating: Gold over Nickel

Features

- Open top sockets for QFP packages using a shoulder contact system
- Universal socket for both long and short IC leads
- Contact system protects the IC lead from wear and tear during testing

Applicable Dimensions (Reference Only)

Outline Socket Dimensions

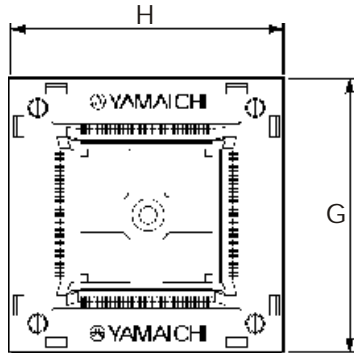

Part Number (Details)

IC234 - 120 4 - 017 *

Series No.

No. of Contact Pins

Number of Sides with Contacts

Design Number

Positioning Pin

N = Without Positioning Pin
 P = With Positioning Pin

Contact Details

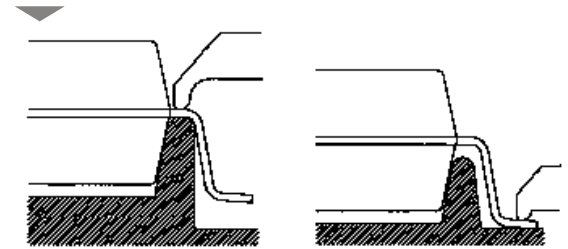

Shoulder Contact, for IC234 Series

Conventional Bottom Contact

Outline IC Dimensions

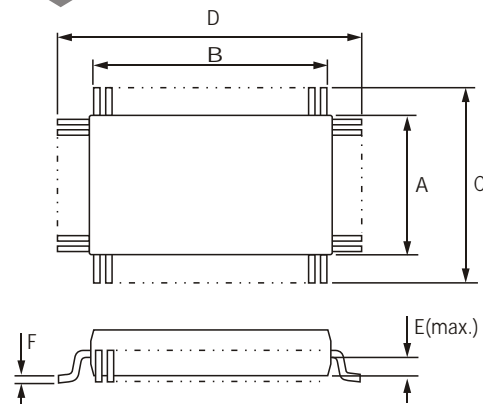

Part Number	Pin Count	Pitch (mm)	IC Dimensions					Socket Dim.	
			A x B	C	D	E (max.)	F	G	H
IC234-1564-038 *	156	0.4	14.0 x 20.0	16.00	22.00	0.67	0.125	38.0	44.0
IC234-1604-018 *	160	0.65	27.95 x 27.95	32.00	32.00	1.48	0.15	47.6	47.6
IC234-1604-032 *	160	0.65	28.0 x 28.0	30.60	30.60	1.66	0.175	47.6	47.6
IC234-1764-059 *	176	0.4	20.0 x 20.0	22.00	22.00	0.67	0.125	40.0	40.0
IC234-1764-002 *	176	0.5	24.0 x 24.0	26.00	26.00	1.00	0.125	46.0	46.0
IC234-1764-005 *	176	0.5	24.0 x 24.0	26.00	26.00	1.00	0.17	46.0	46.0
IC234-2404-030 *	240	0.5	32.0 x 32.0	34.60	34.60	1.56	0.17	51.6	51.6
IC234-2564-020 *	256	0.4	28.0 x 28.0	30.00	30.00	1.40	0.125	48.0	48.0

IC234 - Open Top with Shoulder Contact

Quad Flat Package (QFP)

Recommended PCB Layouts (156 to 176 pins)

Top view from socket

156 pins

IC234-1564-038

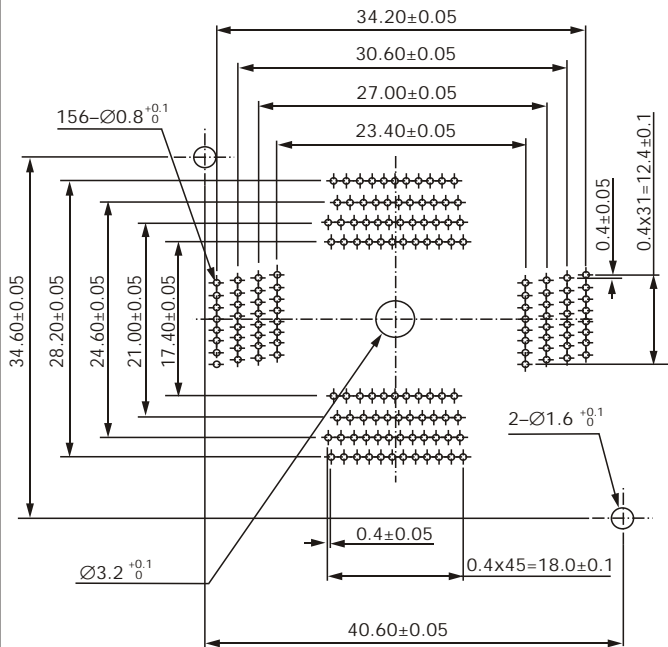

160 pins

IC234-1604-032

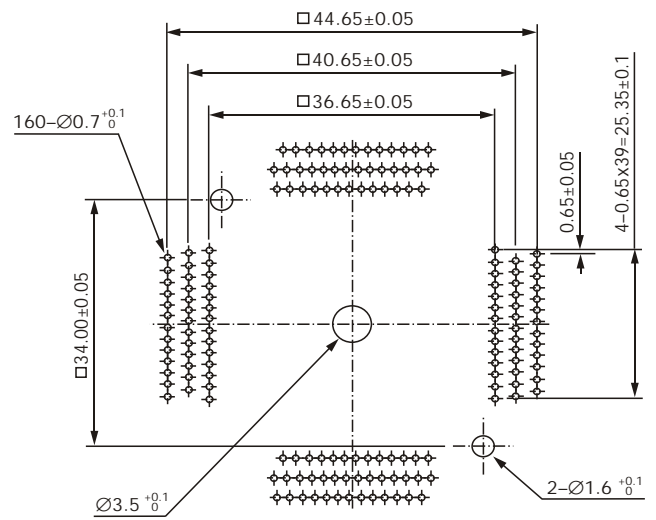

160 pins

IC234-1604-018

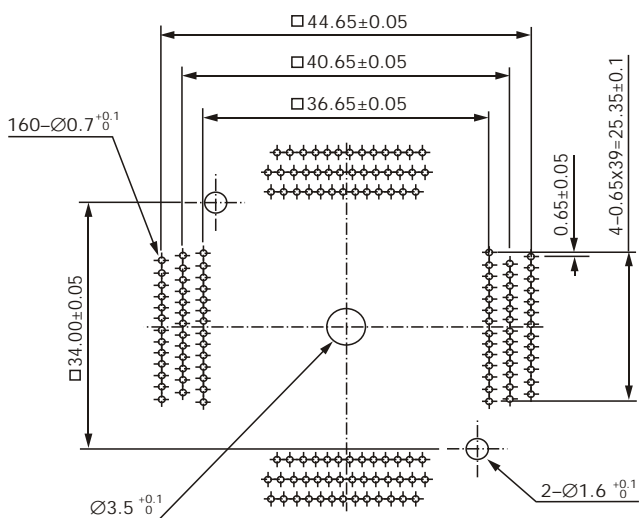

176 pins

IC234-1764-059

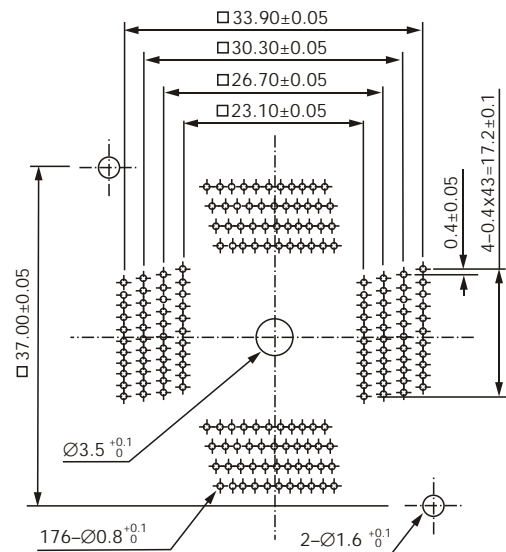

IC234 - Open Top with Shoulder Contact

Quad Flat Package (QFP)

Recommended PCB Layouts (176 to 256 pins)

Top view from socket

176 pins

IC234-1764-002

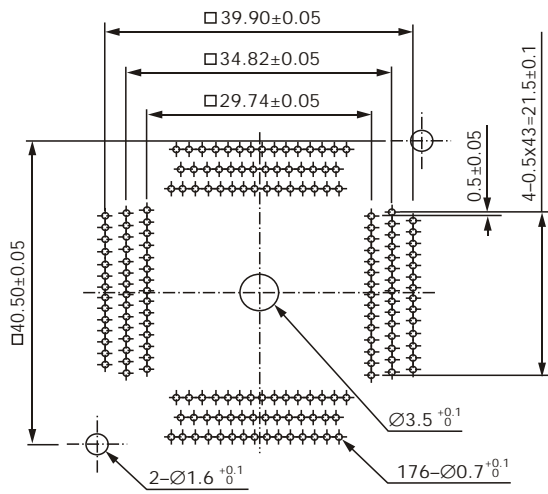

176 pins

IC234-1764-005

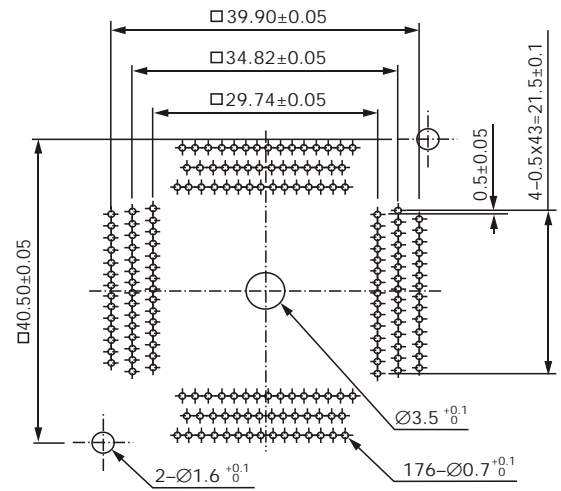

240 pins

IC234-2404-030

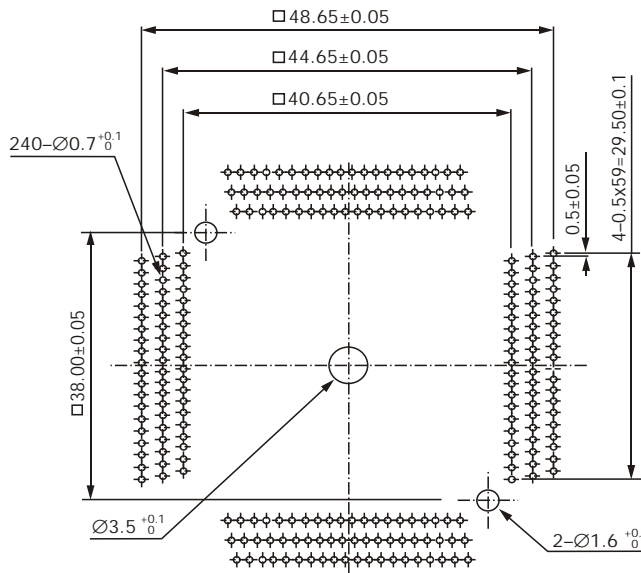

256 pins

IC234-2564-020

